



## From Field to Plate:

# Benefits of Locally Harvested Wild Game in Texas and How to Keep it Safe

Rebecca Dittmar, Mary Pearl Meuth, and John M. Tomeček

Increased interest in the value of food has intensified people's focus on food sources that are local, sustainable, nutritional, and ecologically healthy. Although harvesting wild game is not the norm for most families, there is a trend toward sourcing protein from local markets and the local ecosystem. This trend, called **localism**, was captured in 2007 when the New Oxford American Dictionary recognized "locavore" as the word of the year—a locavore is "a person whose diet consists only or principally of locally grown or produced food." According to Ben Zimmer, editor for American dictionaries at Oxford University Press, "The word 'locavore' shows how food-lovers can enjoy what they eat while still appreciating the impact they have on the environment . . . it brings together eating and ecology in a new way."

\* Extension Assistant – Food Protection Management Program; Texas Master Naturalist Program Assistant State Coordinator; and Assistant Professor and Extension Wildlife Specialist, Department of Wildlife and Fisheries Sciences, all of the Texas A&M University System

Many locavores now include those who produce or harvest local game animals. By participating as a locavore, there are typically four main benefits:

- participating in ecosystem management through population control
- engaging in an alternative food market environment for food sources
- increasing contact with nature, which leads to greater well-being
- achieving physical health benefits from outdoor recreation and nutritional benefits from animal consumption.

### Ecological benefits

Hunters were the "original locavores." Early settlers foraged their local ecosystems for greens and grains as well as game. As populations of game animals fluctuated, settlers changed their tactics to a seasonal, forage management, and migratory approach. Today, these same strategies apply to con-

suming wild game from local herd stocks. Conservation-oriented hunters and local biologists evaluate the local ecosystem’s population capacity for a given game animal each year. Animals are harvested accordingly to alleviate pressure when necessary to enhance population sustainability. For example, white-tailed deer in Texas are overabundant in many areas. When habitats do not have the ecological resources to sustain large populations, herd health suffers. Harvesting animals relieves pressure by reducing populations to sustainable numbers. If managed correctly, hunting can also be used to control the gender distribution of games species within a population. Using census information and understanding appropriate gender ratios for the local ecosystem, you can determine the harvest or capture ratios needed to achieve sustainable growth of the game population.

## Environmental footprint

Harvesting wild game also relieves the ecological footprint of traditional agricultural livestock. Currently, about 90 percent of the US’s food-based footprint comes from livestock production for meat—beef (79 percent), chicken (3 percent), pork and lamb (4 percent), dairy (4 percent), etc. The ecological footprint for wild game, such as white-tailed deer, quail, turkey, and others is small compared to traditional meat sources. The ecological footprint of the average US citizen totals 3.04 acres. This includes 1.36 acres per capita dedicated to food production, 1.60 acres per capita of wood products, and 0.08 acres per capita of land taken out of ecological availability by buildings, roads, parking lots, etc. Reducing our reliance on traditional food production acreage can benefit the overall ecological system.

## Time with nature

Outdoor exploration and hunting are beneficial in that they bring adults and children into contact with nature. In general, there has been a measured decrease in the time adults and children spend outside, and this has led to an increase in behavioral, biological and emotional problems. According to the Environmental Protection Agency (EPA), the average American spends 93 percent of their life indoors

(87 percent indoors, 6 percent in automobiles). Only 7 percent of is spent outdoors. Unstructured play in nature increases brain stimulation because there are more opportunities for interaction. Researchers at the University of Michigan have found that after an hour of interacting with nature, memory performance and attention span increased by 20 percent. Exposure to nature also helps people develop closer relationships with others and place a higher value on community.

## Nutritional benefits

Wild game is an excellent source of lean protein. Game meats like venison are also an excellent source of iron and zinc. With the exception of dove, which is an excellent source of iron, most game birds contain less zinc and iron than other wild game.

Game meat can provide a nutritious, delicious and sometimes less expensive alternative to traditional meat products sold in the grocery store; however, safe handling and processing in the field, along with proper storage, is critical to preventing spoilage and foodborne illness.

**Table 1. Nutrient content of domestic and game meats (3½ ounce portion)\***

	Calories	Protein (grams)	Fat (grams)
<b>Domestic Species</b>			
Beef (USDA Choice)	180	22.0	6.5
Pork	165	22.3	4.9
Chicken	135	23.6	0.7
Turkey	146	23.5	1.5
Pheasant	144	23.9	0.8
<b>Wild Game</b>			
Turkey	163	25.7	1.1
Duck (Mallard)	152	23.1	2.0
Squirrel	149	21.4	3.2
White-tailed deer	149	23.6	1.4
Pheasant	148	25.7	0.6
Dove	145	22.9	1.8
Mule deer	145	23.7	1.3
Rabbit (Cottontail)	144	21.8	2.4

\*Adapted from North Dakota State University Wild Side of the Menu No. 1 Care and Cookery

## Harvesting wild game

As the number of hunters steadily declines in Texas and elsewhere, among the most-often cited reasons are the cost and a lack of knowledge. Hunters increasingly lack the desire or experience to process their own game—from carcass to finished cut meat—but instead take it to a commercial processor, which has an added cost. What follows is an introduction for the beginner.

### Setting—in the field or at the camp

There are a few choices as to where to process a game animal. These are a matter of facilities and convenience. Generally, you can process in the field or at the hunting camp. Make this decision before you leave for the field. Remember that state game laws dictate when, where, and to what extent you may process a carcass. Be certain to know the relevant rules, or call a Game Warden for advice when planning your hunt. Texas regulations can be found in the Texas Parks and Wildlife Department's Outdoor Annual: <https://tpwd.texas.gov/regulations/outdoor-annual/>.

#### *In the field*

For inexperienced hunters, the prospect of processing “in the field” may seem daunting, awkward, or simply unsanitary. In fact, for those hoping to hunt large animals, such as elk and bear on public lands, field processing is essential to removing your meat from the field—these animals are usually impossible to remove whole. Even if you plan to process “at camp,” being equipped to do so in the field is good preparation for unexpected circumstances.

Processing in the field begins with the basic “it’s on the ground, so now what?” First, assess whether you can move the carcass whole. If it is a small animal, such as a rabbit, this is no problem. If, however, you have harvested a 250-pound wild pig, then you might need to lighten the load by removing the internal organs. Some animal carcasses will weigh too much even without organs. In these cases remove the legs and muscles along the spine. This is referred to as quartering, and it yields most of the meat from a carcass leaving the spine, rib cage, and skull in the field.

#### *At camp*

Processing at camp doesn’t mean a rustic encampment reminiscent of mountain men. Rather, it refers to being at a permanent location equipped to make processing easier, faster, or simpler to achieve by one’s self. In any case, processing at camp has its own set of needs and procedures.

Typically in camp, one has access to carcass handling tools that will help hold the carcass while it is processed. For game of various sizes, these are described below.

### The right tools for the job

Regardless of where you process your carcass, you must have the right tools for the job. Bringing home a safe cut of meat for the whole family starts with good preparation. Below is a profile of the tools to include in your toolkit.

#### **Sharp knife:**

What could be simpler than getting a sharp knife? The reality is that for processing wild game, there are many choices available. Although you could use any knife, there are specific types that the hunter-processor should have.

**Hunting knife:** This is a general-use tool in the field and a good one can accomplish nearly, if not all tasks required for processing game meats. These generally have blades that are 3.5 to 6 inches long and are made of strong, durable steel. They may fold or be fixed-blade. You can find a quality hunting knife in nearly any sporting goods or hardware store.

**Boning knife:** This knife is typically used to cut meat away from the bone so it can be processed into various cuts (assuming that the cut does not include bone, such as T-bone). These are relatively hard knives that are intended to contact bone occasionally, although they are not intended for cutting through bone or joints. A good quality knife is available from restaurant suppliers and larger sporting goods stores for around \$20. Lengths vary, but most hunter-processors use 5- or 6-inch knives.

**Butcher knife:** Butcher knives are what you should use to cut larger, boned-out pieces of meat into component cuts. The steel in these knives

is designed to maintain a fine edge, and is not intended for regular contact with bone. Various lengths are available. For larger animals, an 8-inch butcher knife works well.

**Fillet knife:** Extremely thin and flexible, these knives are at their best when removing the skin from fish or carefully separating delicate flesh from bone. They are essential for removing the “silver-skin” from the outside of large muscles. They are not suitable for splitting sternums or other heavy-duty tasks.

**Paring knife:** Short bladed and sturdy, these knives are best for work that is too fine for large blades. A paring knife is excellent for all-around processing of small game birds, small game, and fish. In addition, they are useful for removing shot from harvested game, or trimming tissue from around bullet fragments.

**Sharpening tool:** Whether a steel or ceramic rod, you need some way to sharpen your knives. To ensure the best results, you will need to hone or touch-up the edge on your knives during processing. Learn what types of edge your knives have and maintain the angle of the grind.

**Saw:** Traditional butchers’ saws have a place in the wild game butchering. These are used to separate sections of animal by cutting through the bone, or for certain cuts of meat that contain bone (T-bone, etc.). These are best used on large game.

**Reciprocal saw:** Reciprocating saws are common in hunting camps today. These tools, designed originally for construction, are efficient when removing hindquarters from a fully dressed, skinned carcass.

**Game shears:** One of the most versatile tools available, game shears are used for removed wings from birds, legs from animals, and even cutting certain cuts of meat into bite-sized pieces. Quality shears are available from nearly any sporting goods store. Kitchen shears will work, too.

### ***Carcass handling tools:***

For small game and most birds, carcass handling can be done in-hand or on a surface such as a table or countertop. In the case of large game, however, tools that help you hold and manipulate carcasses are essential.

**Gambrel hoist or rope:** To use this tool you make an incision between the Achilles tendon and leg bone. A gambrel or rope is run through each incision, and the animal is hoisted off the ground to ease processing. Although it is common to hang animals head-down, they may also be elevated by tying a rope around the head. Versions of this tool that fit vehicle trailer hitch receivers are available—these are a compromise between field methods, such as suspension from a tree, and processing at a dedicated facility in a hunting camp.

**Carcass cradle:** Carcass cradles are another way of holding an animal. These resemble an X-shaped frame, and have boards or rails that hold the carcass in place, back down, to be gutted and skinned. Afterward, the carcass may be hung for final processing. This method can also be used in the field when the carcass is too heavy to remove whole. You can also use logs, rocks, or any other sturdy object to hold a carcass in place in order to remove the internal organs; this will help you move carcasses from the field.

### ***Meat packing tools:***

There are various ways to prepare game meat for storage. The easiest are paper wrapping and vacuum packing. Instructions and considerations are detailed on pages 12–13.

Vacuum packing is achieved by using a device that creates a vacuum in a food-grade polyethylene bag, and uses heat to seal the bag once the air has been removed. Meat packed in this anaerobic environment and subsequently frozen and can last much longer than traditional packing techniques.

### ***Personal protection equipment (PPE):***

When processing a carcass, you can be exposed to a variety of parasites, diseases, and other contaminants. Fortunately, proper cooking will remove nearly all of these from game meat. However, when processing, you should wear latex or nitrile gloves, cover all open wounds, protect your nose and mouth from inhalation, and keep a sanitizer handy for your tools and hands.

## Processing the carcass: Waste not, want not

Responsible use of wildlife centers on the concept that we use everything we can from the animal we take. There are many uses for harvested animals that people overlook. We will outline these and suggest additional uses after addressing the most common cuts.

### Large game

A large game animal, such as a deer, antelope, or feral pig, might be daunting to the new hunter-processor. Although the carcass is large, the same principles apply to processing any mammal for the table. The large game animal will provide a variety of meat for the table, and the beginning processor can make a few mistakes without losing a significant portion of the edible meat.

Tips for field processing are outlined and pictured below using a white-tailed deer as reference. These same techniques can be applied to other large and some small game animals.

Once large game animals have been harvested, removal of the internal organs is the most critical step to reducing carcass temperature. Cooling the carcass quickly is extremely important to reduce the potential for spoilage and bacterial contamination. There is more than one way to eviscerate large game, and a number of factors that should be considered when choosing a method. Following harvest, field dressing is the quickest way to get the internal organs removed and the core carcass temperature dropping. Arrange the carcass so that you have easy access to the underside (belly) of the animal (Fig. 1). You can do this with a cradle, hoist, or on the ground, as detailed previously.



Figure 1.

Start by cutting around the male genitalia or mammary glands by gripping and pulling them away from the body with your off hand (Fig. 2). Carefully cut the skin around these parts, not so deep to puncture the body cavity, but deep enough to remove the organs (Fig. 3).



Figure 2.



Figure 3.

Mammary glands can be totally removed and discarded. Male genitalia should be dissected towards the anus following the urethra (Fig. 4).



Figure 4.

At this point, detach the rectum and genitalia from the pelvic cavity. To achieve this, first make an incision in the skin around the anus and genitalia to free it (Fig. 5).



Figure 5.

Again, using your off hand gently apply pressure by pulling the detached parts away from the animal's body. Carefully insert your knife into the pelvic cavity, gently cutting around the wall of the pelvis to free them (Fig. 6).



Figure 6.

Extreme care should be taken not to puncture the intestines or urinary track as these are potentially significant sources of bacterial contamination and meat spoilage. Tying a string or putting a rubber band securely around the colon and urinary track is a great way to prevent leakage as these parts are removed later.

Once the genitalia and rectum are free and ready for removal it is time to open up the body cavity. Start by making an incision from where you removed the male genitalia or mammary glands towards the head of the body along the center line exposing the abdominal muscles and sternum (Figs. 7 and 8).



Figure 7.



Figure 8.

Now, make a small incision in the abdominal muscle where they attach to the pelvis creating a small opening in the body cavity (Fig. 9). Avoid puncturing the membrane containing the internal organs.



Figure 9.

Next, insert two fingers into the incision with your nondominant hand, and pull upward slightly (Fig. 10). Using your dominant hand, carefully slit the abdominal muscles towards the head of the animal, avoiding the internal organs.



Figure 10.

Once you encounter the sternum, use a saw, loppers, or a stiff knife to separate the sternum. Continue your cut up to the throat (Fig. 11).



Figure 11.

Once you have successfully opened the body cavity, turn your attention back to the anus and genital region. Reaching inside the body cavity, firmly grasp the colon at the base of the pelvis and pull the detached anus and genitalia through the pelvic cavity (Fig. 12).



Figure 12.

Turning the animal on its side at this point makes it easier to remove the internal organs. Carefully cut the diaphragm that separates the digestive organs from the pulmonary organs (Fig. 13).

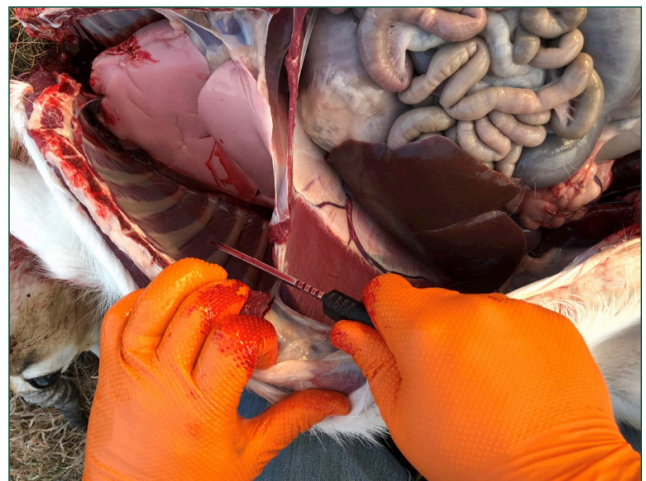

Figure 13.

Firmly pull organs out of the body cavity. Your knife might be required to cut through the vascular areas that attach to the organs around the kidney, diaphragm, and around the heart area. If you wish to use some organs for meat products, set them aside now. The heart and lungs are com-

monly damaged by a bullet. If any of the muscles have been pierced by the bullet, it is best to remove those sections—do not use them for consumption. During this step, pay special attention to the presence of parasites inside of the carcass. These may include tapeworm cysts, which appear as water-filled spheres, or flukes, that may look like inclusions in the liver or other organs. If you notice internal parasites, do not use any organs for food products. Dispose of all unused organs. If you have water available, rinse the inside of the carcass to remove excess blood and any remaining organ fluids.

Some hunters and processors prefer to skin the animal before gutting it to minimize hair inside the carcass. This is personal preference, and depending on your facilities, time frame, and weather conditions it might be the ideal practice. If you prefer this method, the next steps will be performed before the internal organs are removed.

At this point, you should suspend the carcass and skin it using a gambrel hoist or a rope as described earlier (Fig. 14). You can start with the head region or at the hind legs.



Figure 14.

From the hind end, cut all the way around each hock, near where you would suspend the carcass, then make an incision on the inside of the legs toward the groin. Do not cut deeply, pierce only the skin. Gently pull the skin back as you make light, quick cuts to sever the connective tissue holding the skin the meat. Slowly work around each leg and down the back, towards the head (Figs. 15, 16, and 17).



Figure 15.



Figure 16.





Figure 17.

When you reach the front legs, remove the lower leg at the knee joint. Make an incision along the leg towards the rib cage (Figs. 18 and 19).



Figure 19.

Continue removing skin towards the head. Gently cut the connective tissue holding the skin to the body (Fig. 20).



Figure 18.



Figure 20.

Remove the head and connected shin by cutting the neck with a saw at the base of the head.

At this point water should be used to remove all foreign objects that could harbor bacteria or reduce meat quality. This includes hair, blood, internal organ contaminants, and environmental contaminants such as dirt or grass. Cutting out extreme bloodshot damage and contaminated meat is important to maintaining the quality and safety of your meat.

Finally, remove the meat by quartering or individual cuts. The normal cuts (Fig. 21) are described by Field (1983) as follows:

**A to B.** Remove the neck and shoulder. You may want to bone out the muscle for ground meat.

**C to D.** Separate the shoulder from the rib between the fifth and sixth ribs (counting from front of carcass).

To remove the backstrap, the most sought-after part of the carcass, cut against the spine from mid-back towards the head. Use your fingers to gently pull the meat back from the spine as your cut. When your knife contacts ribs you are deep enough.

After your incision along the spine, make a lateral cut at the rear of the backstrap. Pull gently downwards and make small, swift cuts with your sharp knife between the ribs and the backstrap to free it from the carcass.

**E to D.** Remove the brisket and foreshank just above the elbow joint. Arm and blade roasts may be cut and trimmed. Portions of the shoulder not suitable for roasts and foreshank may be boned for ground meat.

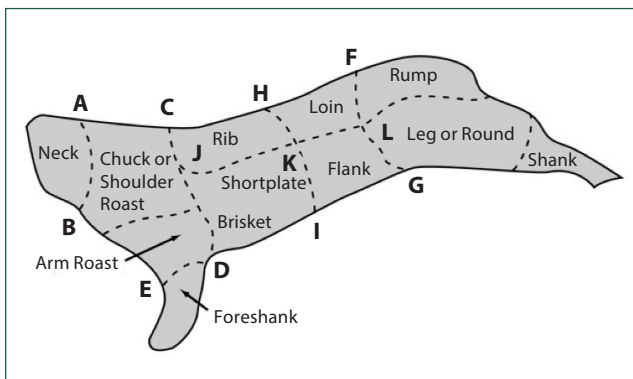

Figure 21.

**F to G.** Cut the leg from the loin, leaving one vertebra on the leg. Sirloin steaks and bone-in leg roasts are made from these cuts. The hind shank and trimmings may be boned and used for ground meat.

**H to I.** Separate the rib and short-plate from the flank and loin by cutting between the twelfth and thirteenth ribs.

**J to K.** The rib is separated from the breast by a 1/2-inch ventral cut to the blade bone on a line parallel to the back. The flank and breast may be boned for ground meat; however, this is advised against since it exposes meat that may have been contaminated during dressing. Boning out ribs is not recommended for the same reason.

**K to L.** The flank is removed from the short loin by cutting next to the tenderloin. The rib and loin may be cut into steaks.

## Small game

Small game mammals, such as rabbits and squirrels, are often the first harvests a young hunter might experience. These animals are fairly simple to hunt, and are also relatively simple to process and use. They are an excellent choice for the beginning hunter-processor.

First, remove the internal organs from the harvested animal. Using a good knife, make an incision towards the hind end of the animal, pinching the skin slightly to avoid puncturing organs. Using a finger, widen the hole, and raise the skin. Use your knife to cut open the carcass long-wise towards the neck and head. Your finger can help raise the skin enough to avoid cutting organs, but take care not to cut yourself. Cut through the sternum. At this point, carefully remove all the internal organs. Cut around the anus to release the end of the intestinal tract.

Next, skin the animal in much the same way as described for large game. In the case of small game, such as rabbits, knives are often not necessary to skin the animal. Hand strength is typically enough to pull the skin from the meat. Be sure to minimize the amount of skin between your hand and the carcass, as larger amounts are prone to ripping.

Finally you can separate cuts of meat, or use the carcass whole. Processing the carcass can be accomplished as with large game, but many recipes that use rabbit meat simply cut the meat from bone and cut it into cubes or similar pieces. Other recipes require the whole carcass to be cooked, then the meat boned out.

### Game birds

Most all game birds are palatable. Although the size and shape of game birds, from doves and quails to ducks and geese, may differ, the basic processing principles do not. The following outlines game bird processing step-by-step, along with popular practices.

Birds may be plucked, if you wish to use the whole carcass, or “breasted” if you only desire the muscles either side of the keel bone of the breast. Often, if wings and legs have been damaged by shot, it may be more efficient to breast a bird, given the lack of usable meat elsewhere. Many feel that plucking is tedious and unsanitary, but this isn’t necessarily true. There are two methods: “wet” plucking and “dry” plucking.

### Plucking

Plucking can be accomplished wet or dry. The difference is that, in wet plucking, one scalds the carcass at a steaming (not boiling) temperature to loosen the hold of the skin on the feathers. The choice is up to the processor, but many cite wet plucking as superior. Regardless, one should pluck feathers against the grain in a decisive motion. Start with the small feathers and work up to the larger feathers.

For ducks, after plucking there may still be many small feathers on the carcass. At this point, “waxing” can help remove these. Dissolve food grade wax in boiling water. Dip the duck swiftly into the wax mixture, then immediately into a bucket of ice water. Repeat this several times until a layer of wax has built up on the duck. Once fully-cooled and hardened, peel off the wax. The small pinfeathers that were left should release with the wax and leave a clean, smooth carcass.

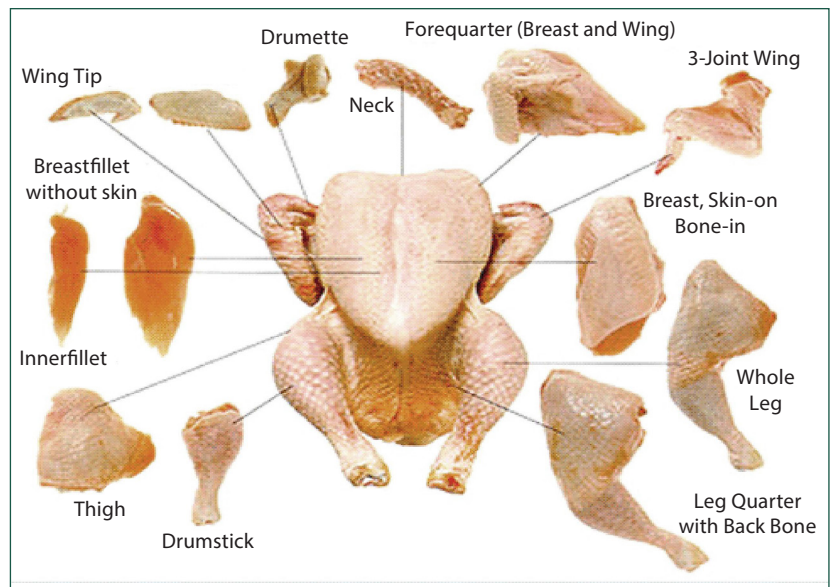

Figure 22.

### Breasting

On a whole carcass, you finally remove the legs and/or wings if not using them. This best done by using game shears to cut cleanly through the joints where the wings join the body, and the legs meet the drumsticks. Pull to remove this section from the body. Then use your boning or fillet knife to cut cleanly along the keel bone and around the large breast muscle to remove it from the bone.

## Common cuts

### Next steps: Beyond the common cuts

Above, we presented the most common techniques for extracting nutritious, high-quality protein from harvested game mammals and birds. With a little practice, most people can gain a confident command of these practices. Some, however, will ask themselves after processing the carcass, “Can’t I do anything with all these leftovers?” The simple answer is “yes,” but learning how to go beyond the common cuts takes more time, skill, and practice. Below, we present the basics, and hope that readers will be inspired to pursue more information related to these practices.

### **Using the scraps:**

**Scrap meat (chislic):** Many cultural groups use the scrap meats during processing. This meat is traditionally cooked by keeping a pot of boiling-temperature oil at hand. Small bits of meat that are otherwise unusable are carved from the carcass and tossed in to flash fry. They are then removed and eaten as an appetizer or snack. Beyond this, scraps can be collected, packed, and prepared in the kitchen later by the same method.

**Organ meats:** Meats from various game organs, like those of livestock animals, can be used. Typically the heart and liver are the most-used part of large game. These can be used for a variety of meat products, and substituted for the same parts from domestic livestock.

**Blood products:** Although relatively uncommon today, products that use blood were once commonplace in the American diet. The blood from game, particularly large game, can be captured for these products. If you want to use the blood, hang the carcass with the head down before gutting or skinning. Pierce the jugular and collect the blood in a sanitary container for later use. The most common use of blood is for blood sausage. As with all other products, it is essential that the food be thoroughly cooked to prevent disease transmission.

**Intestine uses:** The intestines of game animals, especially feral swine, can be used for many products. Properly cleaned and prepared intestines can provide meat for tripe dishes. Additionally, intestines from game can be used as natural sausage casings. This saves the processor money and uses more of the carcass.

Many game animal parts are useful as treats for pets. Commonly, antlers, long bones (such as the femur or tibia), and hooves are given to dogs as treats. Pig tails, ears, and snouts are also common pet products. These may be dehydrated to extend their shelf-life. Do not give bird bones to pets, as they may fragment causing puncture damage.

## **Meat handling safety**

As you process a game animal, good personal safety and protection are critical. While processing an animal, wear latex or nitrile gloves and a long sleeved-shirt, cover any open wounds, and consider a facemask in case of airborne pathogens.

While most game spread relatively few diseases to humans, some, such as feral swine, can transmit a variety of diseases. Additionally, be alert to external parasites. Once animals are deceased, parasites, such as ticks, will search for new hosts. Ticks can carry a variety of infectious diseases.

When hunting with lead-based ammunition, thoroughly remove any fragments of the bullet or shot that remain. When hunting with lead shot, such as for small game or upland game birds, carefully examining the carcass for entrance wounds is essential to finding and removing all lead. With large game, all meat surrounding the wound track of a lead-based bullet should be excised and discarded. If hunting with solid, non-toxic metal ammunition (copper, tungsten, or bismuth), removal of the metal itself is all that is required—no toxic residue will persist.

## **Safe handling and storage of wild game**

After the carcass has been properly field dressed, cut, and cooled to below 40°F, it is ready to be packaged for storage in the freezer. Freezing extends the shelf life of wild game.

Freezing foods at 0°F or below as quickly as possible helps prevent microorganism growth and other chemical changes that can affect the quality of the meat. Freezing, when done properly, has little effect on the nutrient content of wild game meats.

Rancidity in meat is a chemical change that can produce an off flavor when fat has prolonged exposure to air. This can be controlled by removing as much air as possible from the packages before freezing, and using packaging materials that keep air from reaching the meat.

Moisture loss causes ice crystals that can produce freezer burn. This is often described as a discolored, grainy spot where the meat appears dry and tough. This will not cause illness, but it can reduce the quality of the meat by causing 'off flavors'. Proper packaging and rapid cooling can help prevent freezer burn, thereby protecting the palatability and enjoyment of the meat.

The most common way to package meat at home is to use a vacuum sealer and compatible packaging, flexible freezer bags, or butcher/freezer paper. Any of these is effective if done correctly. Choose the method that is best for you.

Follow the vacuum sealer’s recommendations for packaging material usage and vacuum conditions. Do not attempt to vacuum seal using films or packaging materials other than those recommended by the vacuum device manufacturer. If using freezer bags, regardless of type, expel as much air as possible before closing. Follow these basic steps for paper packaging (Fig. 24). Be sure to label all packages with contents and date.

To allow optimal chilling/freezing, meat cuts should be prepared as smaller, individually cut and packaged pieces before placing them in the refrigerator or freezer. Large intact primal and subprimal cuts should not be packaged and chilled/frozen—larger cuts require more energy and time to completely cool/freeze than smaller individual cuts.

Be sure your freezer is in a cool, dry, ventilated place. Never place a freezer in the direct sun or next to a water heater or stove. Also, be sure the freezer sits level and avoid overloading your freezer as

this will slow down the freezing rate and possibly damage the meat’s quality. Spread the packages—this allows air to circulate between the packages and helps the meat freeze faster. For best quality, the USDA recommends consuming frozen wild game within 8 to 12 months. If storing meats in the refrigerator, keep foods at 40°F or below and consume or freeze within 2 to 3 days. Store meats separate from other foods to avoid cross contamination and use an appliance thermometer to ensure your refrigerator is maintaining proper temperatures.

### Preparing wild game

As mentioned, if you plan to consume the meat immediately, keep it in the refrigerator and use it within 2 to 3 days. If using meat from the freezer, be sure to thaw it properly. It is important to keep foods out of the temperature danger zone of 40 to 140°F. Within this range pathogens can grow very







	<b>Step 1:</b> Wrap meat in plastic/cling wrap.		<b>Step 5:</b> Fold ends tightly to form a "V".
	<b>Step 2:</b> Place wrapped meat in the center of butcher/freezer.		<b>Step 6:</b> Flip package so that the seam is down. Fold ends over each other.
	<b>Step 3:</b> Bring opposite sides of paper together and fold edges down about 1 inch deep.		<b>Step 7:</b> Seal edges with freezer tape.
	<b>Step 4:</b> Push air out while folding down.		<b>Step 8:</b> Label package with contents and date.

Figure 23. Basic steps for paper packaging. See video at <https://www.youtube.com/watch?v=oChAoQ21b3A>

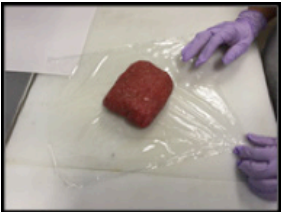
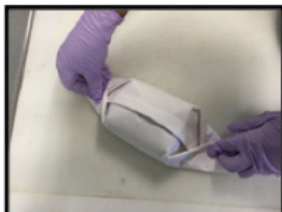
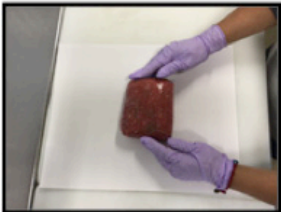
quickly and potentially cause foodborne illness. It is best to thaw meats in the refrigerator. However, this requires planning ahead because of the amount of time it takes. Other ways to thaw meats include, defrosting in the microwave, under cool water, or as part of the cooking process. If thawing in the microwave, cook the food immediately after removing it from the microwave because the meat may have become warm enough to fall into the danger zone. When thawing in cool water, keep the meat under cool running water until it's fully thawed.

Once the meat has been properly thawed remember to avoid cross contamination. This spread of germs from one surface to another can happen at any point from field to plate. Before handling raw foods, wash your hands with warm soapy water for a minimum of 20 seconds. The Centers for Disease Control and Prevention (CDC) say that hand washing is one of the most effective ways to prevent the spread of germs. Also, wash all food contact surfaces (counter tops, cutting boards, utensils etc.) before and after use to help avoid cross contamination. After you have washed these items, sanitize them with a solution of 1 tablespoon chlorine bleach per gallon of water (or 1 teaspoon per 4 cups of water). After submerging the items or thoroughly wetting them with the solution, allow them to air dry. Make a new sanitizing solution each day or when the solution becomes dirty. When wiping up spills or cleaning up kitchen surfaces, use paper towels and discard them. If you use cloth towels, wash and dry them on the hot cycle of the washing and drying machines. Always use separate cutting boards and utensils for raw foods. Ready to eat foods like salads, breads, and deli meats etc., should be prepared on a different cutting board. By following these basic food safety steps, you can avoid cross contamination.

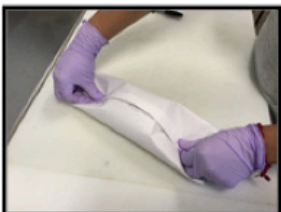
### **Cuts of game and suggested uses**

Game meats can be cooked and served in a variety of ways. The cut will determine, to some extent, the way it is cooked. In part, the age of the animal also influences the natural tenderness of most meats. Often, meat from young animals requires less cooking time than that from older animals.

Cut	Suggested use
Hind and fore shank	Soups, stews, grind for sausage, meat loaf, and patties
Ham or round of the carcass	Usually tender enough for steaks. If not, use for Swiss steaks or grind.
Leg muscles (trim connective tissue)	Cut into strips across the grain of muscle and fry or grind. If ground, remove fat and add beef fat.
Backstrap or loin	Steaks or choice roasts.
Shoulder or chuck roast	Pot roasting or grind the meat.
Flank and breast cuts	Soups and stews or grind.
Heart and liver	Cut into strips and fried.

### **Preparation**

It is fun to try new recipes and to make up some of your own. Expect some failures along with successes when you are experimenting with big game cooking. General rules for successful cooking of game meats are:

- Keep foods out of the “temperature danger zone” of 40 to 140°F.
- Properly cook game meat. The United States Department of Agriculture (USDA) recommends cooking venison, rabbit, and wild hog products to a minimum internal temperature of 160°F and game birds to a minimum internal temperature of 165°F as measured with a food thermometer.
- Hold cooked foods at proper temperatures. Use a food thermometer to ensure that cooked food is held at safe temperatures until served. Cold foods should be held at 40°F or below. Hot food should be kept hot at 140°F or above.
- Use acid to tenderize. Vinegar, tomato sauce, and French dressing sauces are good for tenderizing big game. Cover slices or chunks of meat and allow meat to sit in the marinating sauce for at least 24 hours in the refrigerator.
- Reduce the sugar in sauce recipes. The natural flavor of game meats is typically sweeter than other meat so sauces made for domestic meats may be too sweet.
- Remove all visible fat before cooking. The gamey flavor is exaggerated in the fat. If fat

is desired, ground pork or beef fat may be substituted.

- Big game meat tends to be dry, it helps to add moisture.

### **Roasting — Tender cuts**

- Trim off game fat.
- Season as desired.
- Place on roasting rack in uncovered pan, bone down.
- Baste as needed to help increase moisture and flavor.
- Roast uncovered at 300 to 350°F. Allow 20 to 25 minutes per pound.
- Use a meat thermometer to determine if the food is cooked to a minimum internal temperature of 160°F.

### **Braising — Less tender cuts**

- Season as desired and rub with flour.
- Brown on all sides in sunflower, canola, or vegetable oil.
- Add small quantity of water (about 2/3 to 1 cup).
- Cover tightly.
- Cook very slowly (simmer) until tender (2 to 3 hours). Turn the meat occasionally, adding water if necessary.
- Use a meat thermometer to determine if the food is cooked to a minimum internal temperature of 160°F.

### **Stewing — Less tender cuts**

- Cut meat into 1-inch cubes.
- Season as desired and sprinkle with flour.
- Brown on all sides in a small amount moderately hot oil.
- Cover with boiling water.
- Cover tightly and cook very slowly until tender. Do not boil.
- Add other ingredients, cook until done.
- Use a meat thermometer to determine if the food is cooked to a minimum internal temperature of 160°F.

### **Pan frying — Tender cuts**

- Heat a heavy frying pan until it is sizzling hot.

- Add 1 tablespoon of low fat cooking oil. Place the meat in the hot pan.
- Brown both sides, turning only once. Reduce heat after browning to finish cooking thick cuts.
- Use a meat thermometer to determine if the food is cooked to a minimum internal temperature of 160°F.

### **Marinating**

Marinades can tenderize and enhance game flavors. Cover the meat with one of the following marinades and allow it to stand in the refrigerator at least 24 hours. Do not reuse marinades that have been in contact with raw products.

- Vinegar to cover steak or roast
- French dressing
- Tomato sauce or undiluted tomato soup
- Tomato juice
- Fruit juice such as lemon or pineapple, or a mixture of many juices, 1/4 cup vinegar, 1/2 cup cooking or vegetable oil, 1/2 teaspoon pepper, and 1/4 teaspoon garlic salt.
- 2 cups water, 2 cups vinegar, 1 to 2 tablespoons sugar, 4 bay leaves, 1 teaspoon salt, 12 whole cloves, 1 teaspoon allspice, and 3 medium-sized sliced onions.
- Garlic salt, salt, and pepper to taste, and equal parts of Worcestershire sauce and two of your favorite steak sauces. This gives a blend of flavors and also is excellent for basting game roasts or thick steaks during cooking.
- 2 tablespoons vinegar, 1 1/2 teaspoons ground ginger, 1 clove minced garlic, 2 tablespoons brown sugar, 1/2 cup soy sauce, and 3/4 cup vegetable oil.
- Commercial marinades
- Milk

### **Using a food thermometer**

Using a food thermometer is the only reliable way to ensure safety and to determine desired “doneness” of products. To be safe, game meats must be cooked to a safe minimum internal temperature to destroy any harmful microorganisms that may be in the food and help prevent foodborne illness. It is recommended game meats be cooked to a minimum internal temperature of 160°F and

game birds to an internal temperature of 165°F as measured with a clean, calibrated thermometer.

Many believe that visible indicators, such as color or texture changes, can be used to determine if food is properly cooked. However, recent research has shown that color and texture indicators are unreliable. Food should be cooked to its recommended minimum internal temperature as measured with a meat thermometer, regardless of color or texture.

The food thermometer should be placed in the thickest part of the food. Avoid touching bone, fat, or gristle. Start checking the temperature toward the end of cooking, but before you expect the dish to be done. Be sure to clean your food thermometer with hot soapy water before and after each use to avoid cross contamination.

Thermometers should be calibrated prior to use. There are two ways to check the accuracy of a food thermometer. One method uses ice water, the other uses boiling water. Many food thermometers have a calibration nut/bolt under the dial face that can be adjusted. Always following manufactures instructions.

#### **Ice water method:**

1. Fill container with ice
2. Add clean water
3. Stir the ice water
4. Submerge stem of thermometer at least 2 inches
5. Wait 15 seconds
6. Read thermometer. If 32°F +/- 2 degrees, thermometer is accurate
7. If not, hold the hex adjusting nut and turn indicator head until pointer reads 32°F

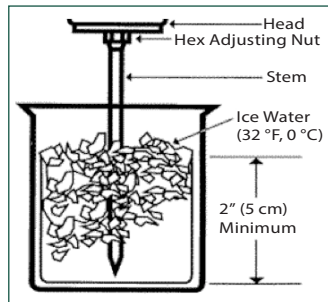

#### **Boiling water method:**

1. Fill pot with water
2. Bring water to a full boil
3. Stir the water
4. Submerge stem of thermometer at least 2 inches

5. Wait 30 seconds
6. Read thermometer. If 212°F +/- 2 degrees, thermometer is accurate

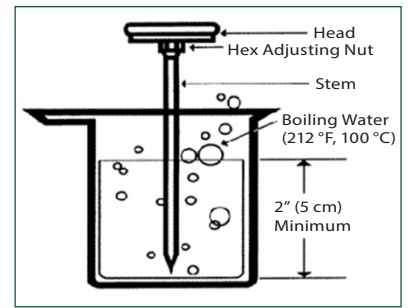

7. If not, hold the hex adjusting nut and turn indicator head until pointer reads 212°F

### **Safe handling and storage of leftovers**

Bacteria grow most rapidly at temperatures between 40°F and 140°F. After foods have been cooked, hot foods should be kept hot at 140°F or higher and cold food at 40°F or below. Once the food has been eaten or removed from a heat source, refrigerate within two hours and consume or freeze it within 3 to 4 days. Foods must be cooled properly to prevent bacterial growth. For larger/whole cuts of meat, cut them into smaller portions. Divide large amounts of food into shallow/smaller containers. Store foods in airtight covered containers. These practices will help avoid cross contamination, help retain moisture, and help prevent leftovers from taking on odors from other foods in the refrigerator. When reheating leftovers, the food should be reheated to a minimum internal temperature of 165°F.

### **Enjoying your harvest**

Bringing wild game home to enjoy with your family provides many benefits including ecological services, nutritional benefits, and quality of life improvements. It can be delicious as well. Following are some well-tested recipes to try at home with your newly harvested, processed, and stored game meat. Take care to observe all precautions and handle the meat with the proper tools and at the proper temperatures.

More wild game recipes can be found here:  
<https://www.ces.ncsu.edu/wildrecipes/>  
<https://tpwd.texas.gov/exptexas/programs/wildgame/>  
[https://tpwd.texas.gov/huntwild/wild/game\\_management/turkey/recipes.phtml](https://tpwd.texas.gov/huntwild/wild/game_management/turkey/recipes.phtml)  
<http://www.mywildkitchen.com/>



# Venison Enchiladas



Photo credit: Noel Stacey, mywildkitchen.com

## INGREDIENTS

1 to 1 1/2 pounds **ground venison**, cooked (to internal temperature of 160°F)  
6 tablespoons cumin  
2 tablespoons chili powder  
1 teaspoon garlic powder  
1/2 teaspoon salt  
1/2 teaspoon oregano  
4 tablespoons vegetable oil  
4 tablespoons flour  
2 16-ounce cans chicken broth (or 4 cups)  
18 corn tortillas  
8 ounces cheddar cheese, shredded  
Optional: avocado, cilantro, sour cream, and salsa

## DIRECTIONS

Precook taco meat until meat reaches an internal temperature of 160°F and keep warm (140° or higher) until use.

Preheat the oven to 350°F.

Prepare the enchilada sauce by combining cumin, chili powder, garlic powder, salt, and oregano. Set aside.

In a medium cast iron or heavy skillet heat oil. Stir in flour and cook, stirring constantly, for 1 minute. Add the spices and stir until crumbled.

Slowly add a little chicken broth to the skillet. Stir to combine, then repeat, adding broth gradually and completely each time.

When the mixture is no longer clumping, add the remaining chicken broth, stir, and simmer for 15 minutes.

Prepare the tortillas and filling:

Warm tortillas in the enchilada sauce or microwave them before

stuffing/rolling. Warming will make them more pliable and help prevent tearing while rolling.

Add 2 tablespoons of ground venison, a sprinkling of cheddar cheese, and 1 or 2 spoons full of enchilada sauce to the center of each tortilla.

Roll the tortilla tightly around the filling, and place in a large casserole dish or 9 x 13 pan. Repeat with the remaining tortillas. Squeeze the tortillas into the pan, if necessary, lining a few around the outer edges of the pan.

Pour the remaining enchilada sauce over the rolled enchiladas and sprinkle with the remaining cheese.

Bake for 10 minutes or until the enchiladas reach a minimum internal temperature of 160°F.

Serve immediately with your favorite toppings: avocado, cilantro, sour cream, or salsa.

9 servings per recipe • Serving size: 2 enchiladas

Calories per serving 350 | 13g Total Fat (17%) | 2.5g Saturated Fat (13%) | 0g Trans Fat | 70mg Cholesterol (23%) | 480mg Sodium (21%) | 31g Total Carbohydrate (11%) | 2g Dietary Fiber (7%) | 2g Total Sugars (Includes 0g Added Sugars (0%)) | 30g Protein | 0mcg Vitamin D (0%) | 238mg Calcium (20%) | 5mg Iron (30%) | 466mg Potassium (10%)

# Creamy Stuffed Meatballs



Photo credit: Noel Stacey, mywildkitchen.com

## INGREDIENTS

1 pound pasta  
Vegetable oil  
2 cups leafy greens (mustard, spinach, Swiss chard, etc.), shredded  
15 ounces skim ricotta cheese  
2 cups nonfat mozzarella cheese  
1 1/2 pounds **ground venison**  
1/2 teaspoon salt  
1/2 teaspoon pepper  
1/2 teaspoon garlic salt  
1/2 teaspoon parsley, fresh  
1 teaspoon minced garlic  
1/2 cup Parmesan cheese  
1 egg  
1/2 cup Italian breadcrumbs  
1 24-ounce jar low-sodium spaghetti sauce  
1/4 to 1/2 cup water

## DIRECTIONS

Prepare pasta according to package directions and drain it.  
Preheat the oven to 375°F.  
Heat a splash of oil in a large skillet.  
Sauté the shredded greens until wilted. Cool slightly.  
Combine the wilted greens, ricotta and mozzarella cheese. Set aside.  
In a large bowl combine ground venison, salt, pepper, garlic salt, parsley, minced garlic, Parmesan, egg, and bread crumbs.  
Mix by hand until thoroughly combined. Scoop out a spoonful of meat and flatten into a thin disc.  
Place a dollop of ricotta mixture in the center of the disc and roll the meat around the ricotta to shape a large meatball.  
Place the meatball on a flat baking pan and repeat until the meat is used up. You should have about half the ricotta mixture left. Set it aside.

Reheat the skillet, adding more oil if needed, and brown the meatballs for about 5 minutes per side until all sides are browned but the center is not cooked through.

Pour the cooked, drained pasta into the bottom of a greased 9×13-inch baking dish. (Top the pasta with the remaining ricotta mixture and arrange the meatballs on top of the ricotta and pasta.)

Pour most of the jar of sauce over the meatballs. Add water to the jar, seal and shake it to combine with the sauce. Pour around the meatballs to soak into the pasta.

Bake the dish uncovered for 30 minutes, or until the center of the meatballs reach an internal temperature of 160°F.

Remove from the oven, top with remaining mozzarella cheese, and bake for 15 minutes until cheese is melted and lightly browned.

Serve immediately.

12 servings per recipe • Serving size: 3×3 square

Calories per serving 370 | 9g Total Fat (12%) | 3.5g Saturated Fat (18%) | 0g Trans Fat | 80mg Cholesterol (27%) | 430mg Sodium (19%) | 39g Total Carbohydrate (14%) | 2g Dietary Fiber (7%) | 5g Total Sugars (Includes 0g Added Sugars (0%)) | 31g Protein | 0mcg Vitamin D (0%) | 347mg Calcium (25%) | 4mg Iron (20%) | 557mg Potassium (10%)

# Wild Pork Carnitas



Photo credit: Noel Stacey, mywildkitchen.com

## INGREDIENTS

3- to 5-pound **wild pork roast**  
2 to 3 tablespoons olive oil  
3 to 5 cloves garlic, minced  
1 tablespoon salt  
Juice from half a lime  
1 can low-sodium chicken broth  
1 to 2 tablespoons fajita seasoning  
1 to 3 bell or poblano peppers  
1 large onion  
Optional: corn tortillas, guacamole,  
cheese, and cilantro

## DIRECTIONS

Trim any extra fat from the wild pork roast and set the roast aside.

Heat 1 to 2 tablespoons olive oil in a large cast iron skillet over medium heat.

Place the roast in the skillet and brown on all sides, about 7 to 10 minutes per side.

While the meat is browning, mix the garlic with the salt to form a paste and pat the paste all over the top of roast.

Transfer the roast to a large slow cooker.

Squeeze the juice from half a lime over the roast, and gently pour the chicken broth over the roast.

Generously sprinkle the roast with fajita seasoning. Cover the slow

cooker with a lid, set it to low heat, and let the roast cook for 8 to 10 hours.

After the roast is fully cooked (an internal temperature of 160°F), carefully transfer it to a large bowl and shred it completely with two forks.

Slice the bell pepper and onion into O's, and cook in the skillet with 1 to 2 Tbsp olive oil until

The vegetables are tender and translucent. Add the shredded roast into the skillet and cook until the roast begins to get slightly crunchy.

Serve the carnitas with warm corn tortillas, guacamole, cheese, and cilantro.

8 servings per recipe • Serving size: 2 carnitas

Calories per serving 300 | 9g Total Fat (12%) | 2g Saturated Fat (10%) | 0g Trans Fat | 70mg Cholesterol (23%) | 460mg Sodium (20%) | 28g Total Carbohydrate (10%) | 1g Dietary Fiber (4%) | 2g Total Sugars (Includes 0g Added Sugars (0%)) | 27g Protein | 1mcg Vitamin D (6%) | 111mg Calcium (8%) | 2mg Iron (10%) | 631mg Potassium (15%)

# Smothered Wild Pork Backstrap



Photo credit: Noel Stacey, mywildkitchen.com

## INGREDIENTS

1 large yellow onion, sliced  
8 ounces fresh mushrooms, sliced  
1- to 2-pound **wild pork tenderloin**, cubed  
Salt  
Pepper  
1 10-ounce can condensed, low-sodium, cream of mushroom soup  
3/4 cup low-sodium chicken broth  
1 tablespoon Worcestershire sauce  
1/2 cup nonfat sour cream

## DIRECTIONS

Layer the following ingredients in the bottom of a large crockpot: onions, mushrooms, wild pork backstrap.

Sprinkle generously with salt and pepper.

In a medium bowl combine cream of mushroom soup, chicken broth, and Worcestershire sauce.

Pour the soup mixture over the meat in the slow cooker. Cover the slow cooker and cook on high for 4 hours or low for 6 to 8 hours, or until the meat reaches an internal temperature of 160°F.

When the meat is cooked, turn off slow cooker and stir in the sour cream. Serve immediately.

---

4 servings per recipe • Serving size: 1 cup

Calories per serving 220 | 6g Total Fat (8%) | 1.5g Saturated Fat (8%) | 0g Trans Fat | 75mg Cholesterol (25%) | 180mg Sodium (8%) | 15g Total Carbohydrate (5%) | 1g Dietary Fiber (4%) | 5g Total Sugars (Includes 0g Added Sugars (0%)) | 29g Protein | 0mcg Vitamin D (0%) | 76mg Calcium (6%) | 2mg Iron (10%) | 831mg Potassium (20%)

## References

- Andrew Joyce, Sarah Dixon, Jude Comfort, and Jonathan Hallett, "Reducing the Environmental Impact of Dietary Choice: Perspectives from a Behavioural and Social Change Approach," *Journal of Environmental and Public Health*, vol. 2012, Article ID 978672, 7 pages, 2012. doi:10.1155/2012/978672
- KG Tidball and PD Curtis, "Extending the Locavore Movement to Wild Fish and Game: Questions and Implications" *Natural Sciences Education*, vol 42, pages 185-189. Doi: 10.4195/nse.2013.0024
- Jon Swenson, "Free Public Hunting and the Conservation of Public Wildlife Resources," *Wildlife Society Bulletin* (1973-2006) Vol 11. No 3 pp 300-303
- Steven Rinella, "Locavore, get your Gun". *The New York Times*, December 14, 2007, page A41.
- Mark Neuzil "Eating+Ecology=Locavore", *Minn Post*, December 3, 20017. <https://www.minnpost.com/environment/2007/12/eating-ecology-locavore>
- "Oxford Word of the Year 2007: Locavore" <https://blog.oup.com/2007/11/locavore/>
- Pete Palmer "Evaluating Ecological Footprints" *Electronic Green Journal*. December 1998, Special Issue 9. Institute for Cambrian Studies, Boulder CO, © 1998
- Neil Klepis et al. "The National Human Activity Pattern Survey (NHAPS): a resource for assessing exposure to environmental pollutants" *Journal of Exposure Analysis and Environmental Epidemiology* (2001) 11, 231-252 (2001). Soi:10.1038/sj.jea.7500165
- Louv, Richard. *The Nature Principle: Reconnecting With Life In A Virtual Age*. Chapel Hill, N.C. : Algonquin Books Of Chapel Hill, 2012. Print.
- Louv, Richard. *Last Child In The Woods: Saving Our Children From Nature-deficit Disorder*. Chapel Hill, NC : Algonquin Books Of Chapel Hill, 2005. Print

The information given herein is for educational purposes only. Reference to commercial products or trade names is made with the understanding that no discrimination is intended and no endorsement by the Texas A&M AgriLife Extension Service is implied.

### Texas A&M AgriLife Extension Service

*AgriLifeExtension.tamu.edu*

More Extension publications can be found at *AgriLifeBookstore.org*

Texas A&M AgriLife Extension provides equal opportunities in its programs and employment to all persons, regardless of race, color, sex, religion, national origin, disability, age, genetic information, veteran status, sexual orientation, or gender identity.

The Texas A&M University System, U.S. Department of Agriculture, and the County Commissioners Courts of Texas Cooperating.